

## 2/2- or 3/2-way- Rocker Solenoid Valve



Type 6128 can be combined with...



### Type 2507

Cable Plug

- Direct acting
- Hermetic isolation of fluid
- Vacuum to 10 bar<sup>1)</sup>
- Orifice 2 or 3 mm
- Manual override as standard
- Sub-base and threaded port version
- 22 mm width per station

### Note

This Type will be replaced by 6628 in 2013

The 6128 analytical solenoid valve combines all state of the art features in a compact design. With high reliability, virtually no heat transfer between fluid and coil, low internal volume and Burkert's expertise in supplying customized solutions, these valves are a perfect fit even for the most demanding applications.

#### Circuit function A

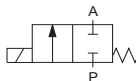

2/2-way valve,  
direct acting,  
normally closed

#### Circuit function B

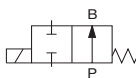

2/2-way valve,  
direct acting,  
normally open

#### Circuit function C

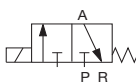

3/2-way valve,  
direct acting, when  
de-energised Port A  
exhausted

#### Circuit function D

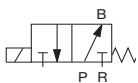

3/2-way valve,  
direct acting, when  
de-energised Port B  
pressurised

### Technical data

<b>Body material</b>	PEEK and PPS
G, NPT connection subbase connection	PPS
<b>Seal material</b>	EPDM or FKM
<b>Medium</b>	Resistant to neutral and slightly aggressive fluids (see chemical resistance chart); technical vacuum
<b>Medium temperature</b>	0 °C ... +70 °C
<b>Ambient temperature</b>	0 °C ... +60 °C
<b>Viscosity</b>	max. 21 mm <sup>2</sup> /s
<b>Port connection</b>	Sub-base G 1/8 NPT 1/8 on request
<b>Operating voltages</b>	24 V DC, 230 V / 50 Hz Other voltages on request
<b>Voltage tolerance</b>	± 10%
<b>Power consumption</b>	5 W
<b>Duty cycle</b>	100 % continuous rating
<b>Electrical connection</b>	<ul style="list-style-type: none"> <li>▪ Acc. to Form B industrial standard for cable plug Type 2507</li> <li>▪ Rectangular plug</li> <li>▪ 500mm leads on request</li> </ul>
<b>Manual override</b>	Standard
<b>Installation</b>	As required, preferably with actuator upright
<b>Protection class</b>	IP40

<sup>1)</sup> Pressure values [bar]: Measured as overpressure to the atmospheric pressure

## Response times

Circuit function	Orifice DN [mm]	Kv value water [m³/h]	QNn-value air [l/min]	Pressure range [bar]	Response times		Max. pressure difference [bar]
					opening [ms]	closing [ms]	
A	2	0,1	104	Vacu-10	18	8	10
	3	0,13	136	Vacu-3	18	8	3
B	2	0,1	104	Vacu-10	18	8	10
	3	0,13	136	Vacu-3	18	8	3
C	2	0,1	104	Vacu-10	18	8	10
	3	0,13	136	Vacu-3	18	8	3
D	2	0,1	104w	Vacu-10	18	8	10
	3	0,13	136	Vacu-3	18	8	3

- Kv value [m³/h]: Flow rate for water, Measured at +20 °C, 1 bar<sup>1)</sup> pressure difference
- Response times [ms]: Measured at valve outlet at 3 bar<sup>1)</sup> and +20°C according to ISO 12238.  
Opening Pressure rise from 0...10%  
Closing Pressure drop from 100...90%

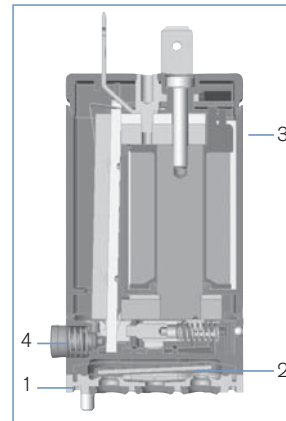

1. Valve body, PEEK / PPS
2. Diaphragm, EPDM or FKM
3. Coil body, PA
4. Manual override, PA

## Ordering chart

Circuit function	Orifice DN [mm]	Body material	Seal material	Voltage/ frequency [V/ Hz]	Port connection	Electrical connection	Item no.
A 	2.0	PPS	FKM	24 V/DC	Sub-base	Rectangular plug	160 758
						Tag connector Form B	160 759
		PEEK/ PPS	G 1/8	Rectangular plug	160 760		
				Tag connector Form B	160 761		
		PPS	EPDM	24 V/DC	Sub-base	Rectangular plug	160 763
						Tag connector Form B	160 764
	PEEK/ PPS	G 1/8	Rectangular plug	160 765			
			Tag connector Form B	160 766			
	3.0	PPS	FKM	24 V/DC	Sub-base	Rectangular plug	160 767
						Tag connector Form B	160 768
		PEEK/ PPS	G 1/8	Rectangular plug	160 769		
				Tag connector Form B	160 770		
PPS		EPDM	24 V/DC	Sub-base	Rectangular plug	160 771	
					Tag connector Form B	160 772	
PEEK/ PPS	G 1/8	Rectangular plug	160 773				
		Tag connector Form B	160 774				
B 	2.0	PPS	FKM	24 V/DC	Sub-base	Rectangular plug	160 775
						Tag connector Form B	160 776
		PEEK/ PPS	G 1/8	Rectangular plug	160 777		
				Tag connector Form B	160 778		
		PPS	EPDM	24 V/DC	Sub-base	Rectangular plug	160 779
						Tag connector Form B	160 780
PEEK/ PPS	G 1/8	Rectangular plug	160 781				
		Tag connector Form B	160 782				

## Ordering chart (continued)

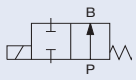
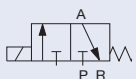
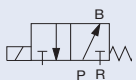
Circuit function	Orifice DN [mm]	Body material	Seal Material	Voltage/frequency [V/Hz]	Port Connection	Electrical connection	Item no.
B 	2.0	PPS	EPDM	24 V/DC	Sub-base	Rectangular plug	160 782
						Tag connector Form B	160 783
		PEEK/PPS		G 1/8	Rectangular plug	160 784	
					Tag connector Form B	160 785	
		230 V/50 Hz		G 1/8	Tag connector Form B	160 786	
					Tag connector Form B	160 787	
	3.0	PPS	FKM	24 V/DC	Sub-base	Rectangular plug	160 788
						Tag connector Form B	160 789
		PEEK/PPS		G 1/8	Rectangular plug	160 790	
					Tag connector Form B	160 791	
		230 V/50 Hz		G 1/8	Tag connector Form B	160 792	
					Tag connector Form B	160 793	
PPS	EPDM	24 V/DC	Sub-base	Rectangular plug	160 794		
				Tag connector Form B	160 795		
	PEEK/PPS		G 1/8	Rectangular plug	160 796		
				Tag connector Form B	160 797		
	230 V/50 Hz		G 1/8	Tag connector Form B	160 798		
				Tag connector Form B	160 799		
C 	2.0	PPS	FKM	24 V/DC	Sub-base	Rectangular plug	160 800
						Tag connector Form B	160 801
		PEEK/PPS		G 1/8	Rectangular plug	160 802	
					Tag connector Form B	160 803	
		230 V/50 Hz		G 1/8	Tag connector Form B	160 804	
					Tag connector Form B	160 805	
	3.0	PPS	FKM	24 V/DC	Sub-base	Rectangular plug	160 806
						Tag connector Form B	160 807
		PEEK/PPS		G 1/8	Rectangular plug	160 808	
					Tag connector Form B	160 809	
		230 V/50 Hz		G 1/8	Tag connector Form B	160 810	
					Tag connector Form B	160 811	
PPS	EPDM	24 V/DC	Sub-base	Rectangular plug	160 812		
				Tag connector Form B	160 813		
	PEEK/PPS		G 1/8	Rectangular plug	160 814		
				Tag connector Form B	160 815		
	230 V/50 Hz		G 1/8	Tag connector Form B	160 816		
				Tag connector Form B	160 817		
D 	2.0	PPS	FKM	24 V/DC	Sub-base	Rectangular plug	160 818
						Tag connector Form B	160 819
		PEEK/PPS		G 1/8	Rectangular plug	160 820	
					Tag connector Form B	160 821	
		230 V/50 Hz		G 1/8	Tag connector Form B	160 822	
					Tag connector Form B	160 823	
	3.0	PPS	FKM	24 V/DC	Sub-base	Rectangular plug	160 824
						Tag connector Form B	160 825
		PEEK/PPS		G 1/8	Rectangular plug	160 826	
					Tag connector Form B	160 827	
		230 V/50 Hz		G 1/8	Tag connector Form B	160 828	
					Tag connector Form B	160 829	
PPS	EPDM	24 V/DC	Sub-base	Rectangular plug	160 830		
				Tag connector Form B	160 831		
PEEK/PPS	G 1/8		Rectangular plug	160 832			
			Tag connector Form B	160 833			
230 V/50 Hz	G 1/8		Tag connector Form B	160 834			
			Tag connector Form B	160 835			

- Rectangular plug supplied **without** cable plug (see ordering chart for accessories).
- Manual override as standard.
- Other versions on request.

## Ordering chart for manifold

Multiple Manifolds with individual service port (G1/8) and diverter function on 2 common channels (G1/8);  
Delivery without valves; Material: anodized aluminium

Manifold	A [mm]	Item no.
2-fold	47	669 571
3-fold	69	672 633
4-fold	91	669 572
5-fold	113	672 661
6-fold	135	669 570
10-fold	223	672 660

▪ Other versions on request.

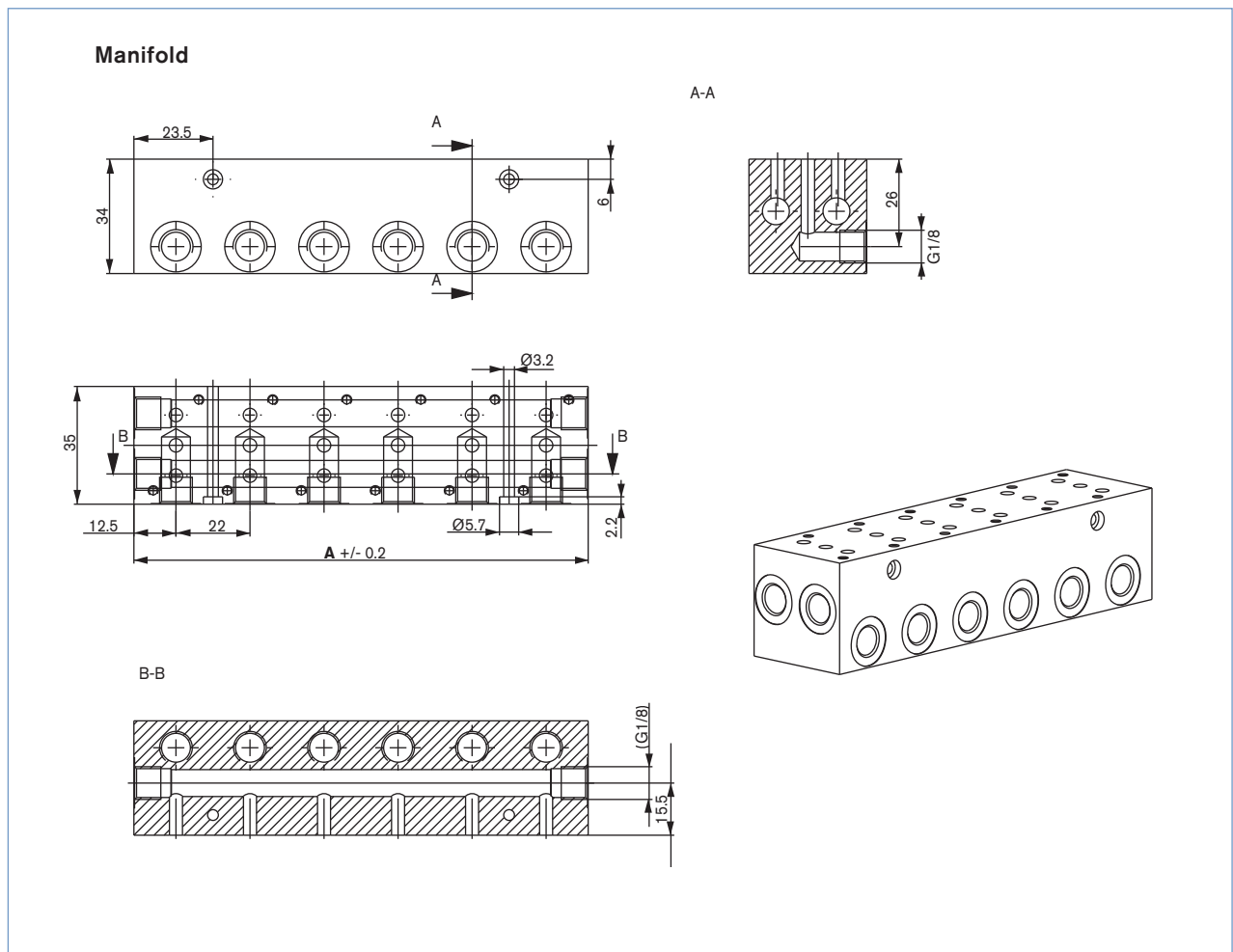



## Ordering chart for accessories

### Cable Plug Type 2507 according to Industrial standard Form B

	Accessories	Version	Voltage	Item no.
	Cable Plug Type 2507	without Circuitry	0 ... 250 V AC/DC	423 845
		with LED	24 V AC/DC	423 849

### Rectangular plug Type 2505

	Accessories	Item no.
	with 3m cable	133 486
	with 300mm leads	644 068
	Single contact for individual mounting	644 067

**Dimensions [mm]**

**Valves with tag connector Form B - Industrial standard**

(The middle connection is not applicable in the case of the 2/2-way version)

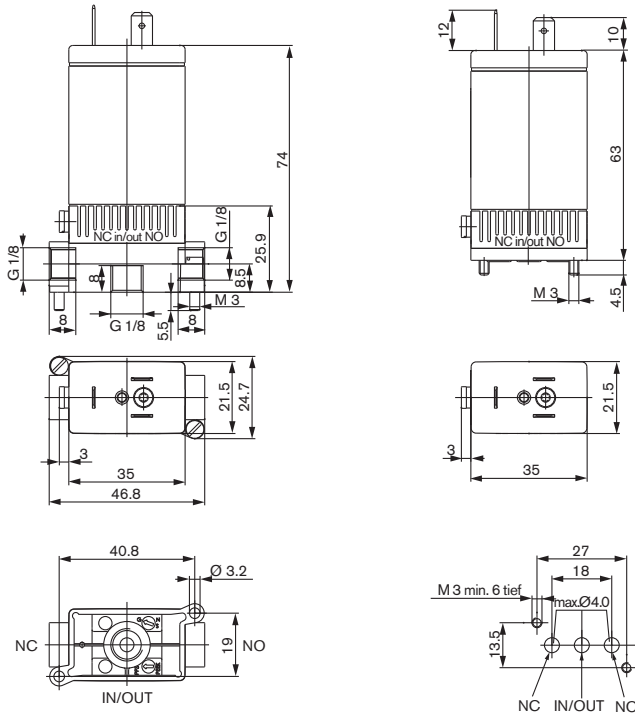

Threaded port body G1/8 manifold mounting (2xM3 screws)

Flange interface for manifold mounting (2xM3 screws)

**Valves with rectangular plug**

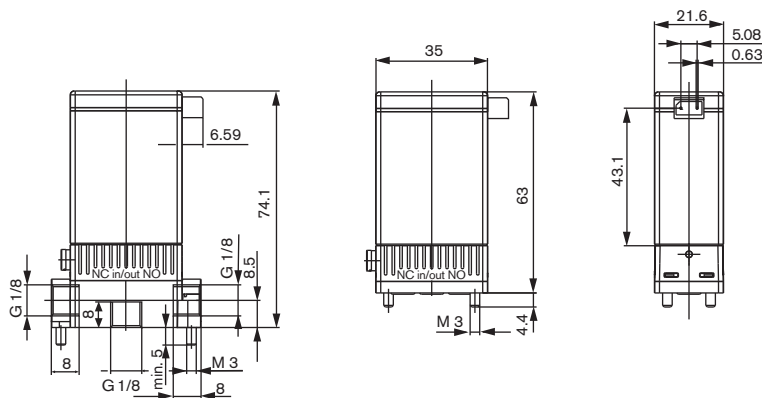

To find your nearest Bürkert facility, click on the orange box →

[www.burkert.com](http://www.burkert.com)

In case of special application conditions, please consult for advice.

Subject to alteration.  
© Christian Bürkert GmbH & Co. KG

1304/9\_EU-en\_00891862